



**SENS LIGHTS**

THE COMPLETE ENERGY SAVING SOLUTIONS PROVIDER

[WWW.SENSLIGHTS.COM](http://WWW.SENSLIGHTS.COM)

# SensLights LED Product Introduction



**LED**

**lumen Multitask**

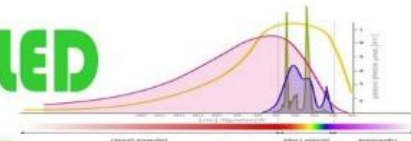

# LED chip



## Prinzipieller Aufbau eines LED-Moduls

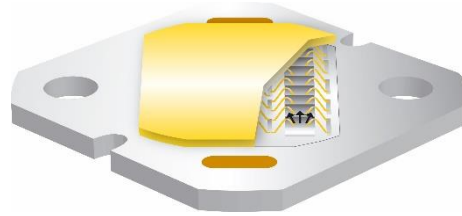
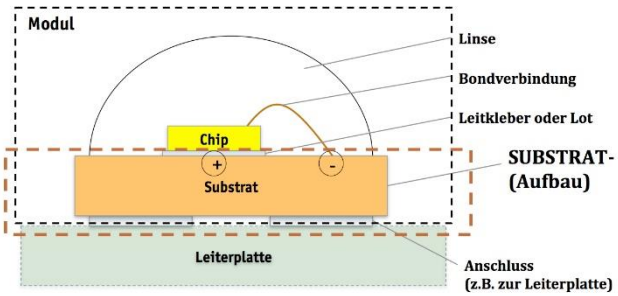

LED Type	T-Pack	Surface Mount	Chip on Board
Device Image			
Packed Array (10mm x 10mm)			
Density	9 LEDs	40 LEDs	342 LEDs
Array Power	0.4 Watts	4 Watts	68 Watts

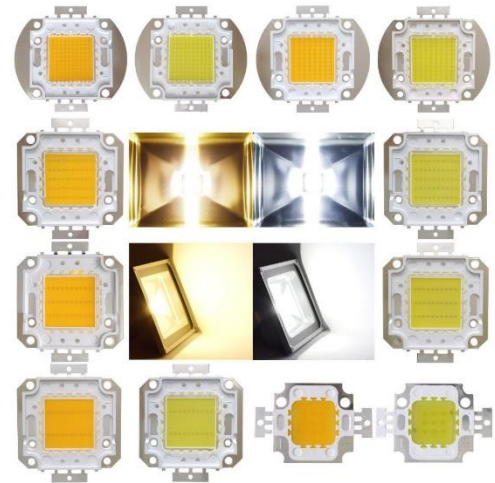

**LED Power Lamps**  
Offers LED power lamps to replace halogen lamps.



**LED White Color SMD**  
Offers LED white colors SMD type Devices for lighting applications



**Multi Color SMD LED**  
Offers multi colors SMD LED Devices for lighting applications



**Mono Color SMD LED**  
Offers mono color LED Devices for lighting applications



**Side View White LED**  
Offers side view LED white colors Devices for back lighting applications

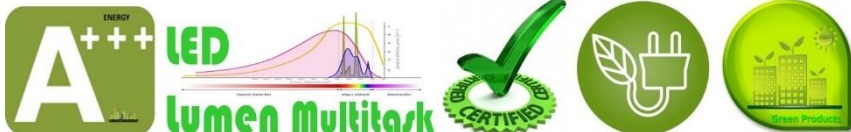

Email: [sales@senslights.com](mailto:sales@senslights.com)

# LED chip

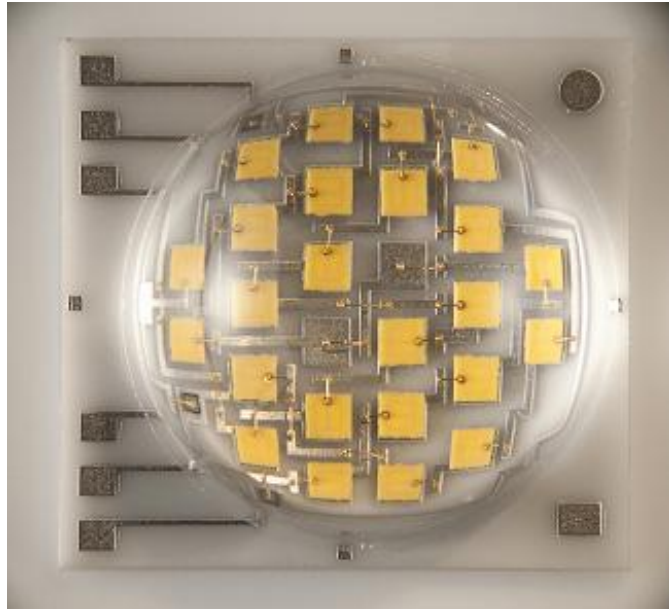

Conventional Module



LED driver

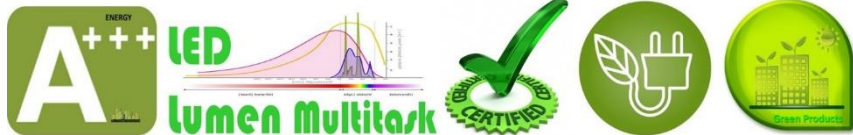

Email: [sales@senslights.com](mailto:sales@senslights.com)

# LED lights driver circuits and PCB

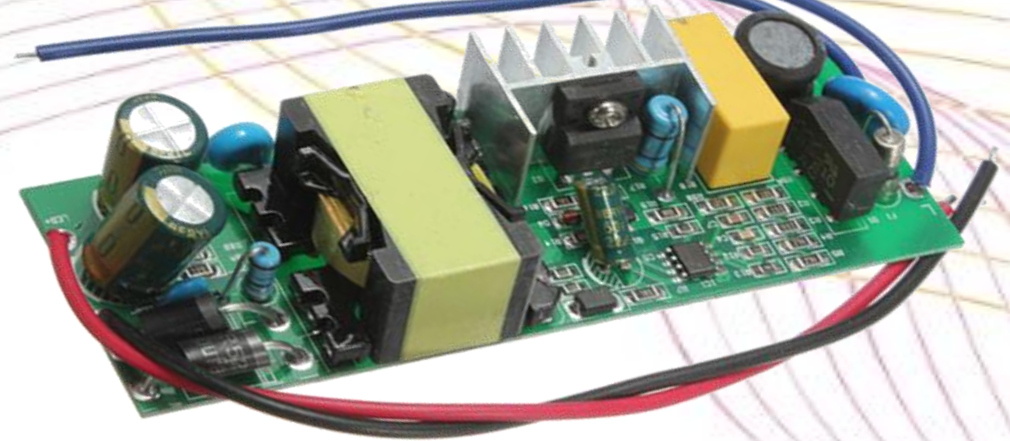
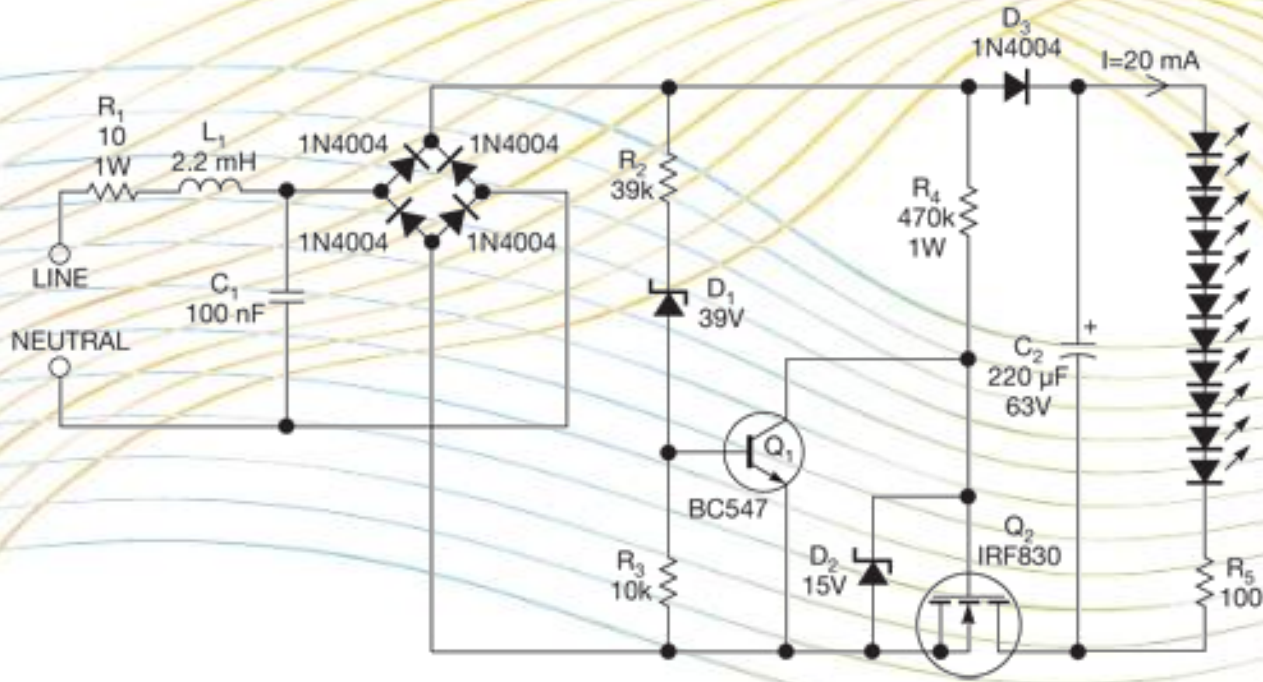

Email: [sales@senslights.com](mailto:sales@senslights.com)



# SMD Downlights

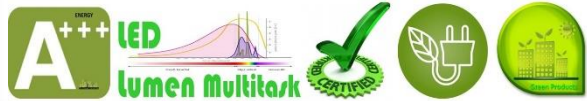

Email: [sales@senslights.com](mailto:sales@senslights.com)

# COB Downlights



Email: [sales@senslights.com](mailto:sales@senslights.com)

# COB Downlights



Email: [sales@senslights.com](mailto:sales@senslights.com)

# COB Downlights

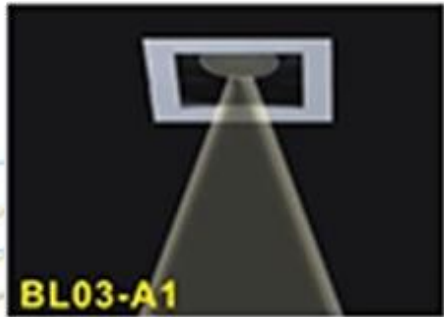

BL03-A1

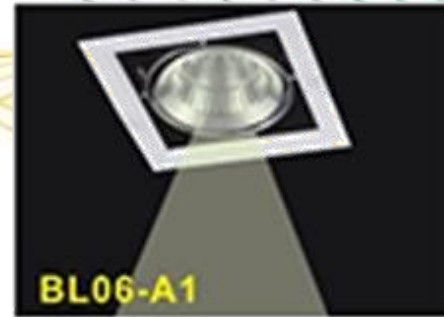
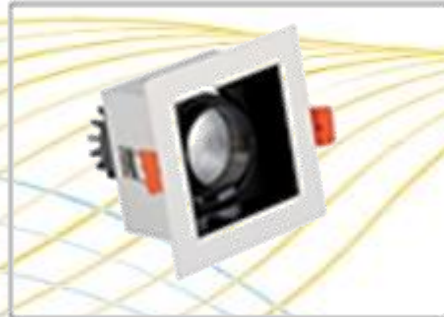

BL06-A1

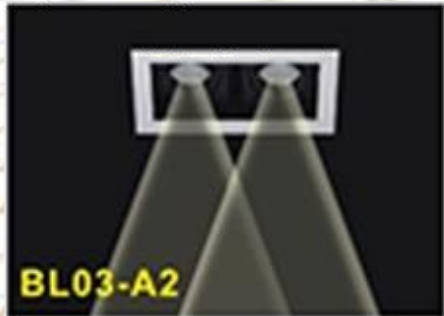
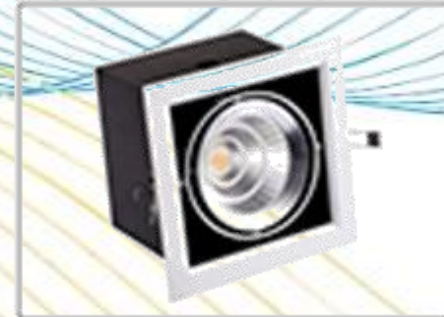

BL03-A2

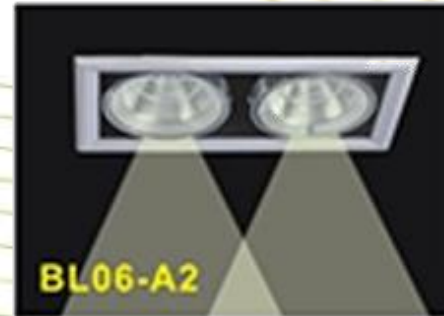

BL06-A2

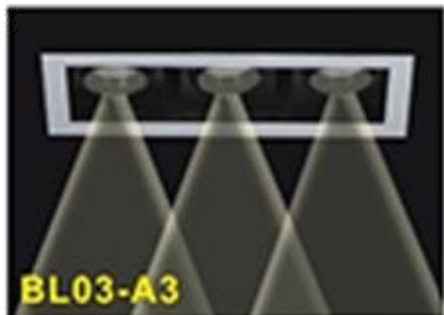

BL03-A3

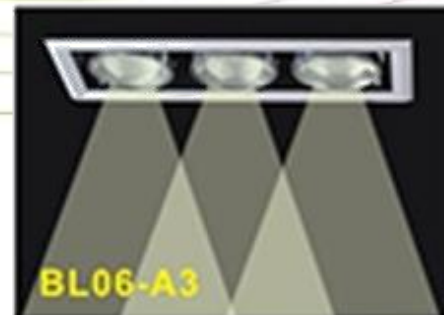

BL06-A3



Email: [sales@senslights.com](mailto:sales@senslights.com)



# LED Sport lights



- 6W/ 8W/ 10W
- 85-265V AC
- 2800-6500K



- GU10/ MR16/ E27
- 60° beam angle
- 50mm cuthole



- Isolated driver
- PF ≥ 0.9
- ≥ 50,000 h lifespan

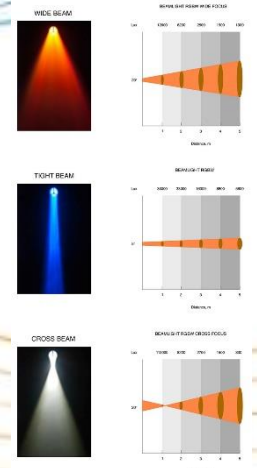
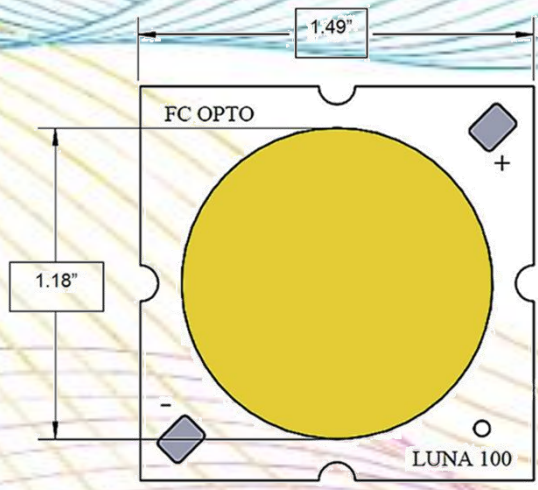
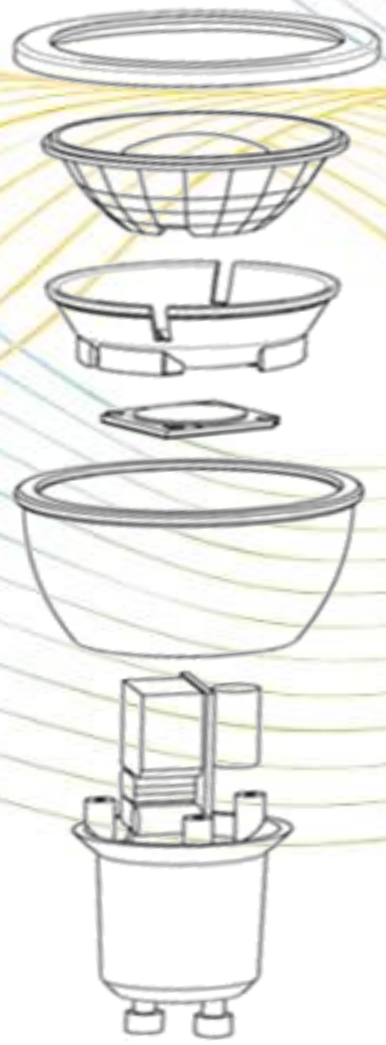

10x90°

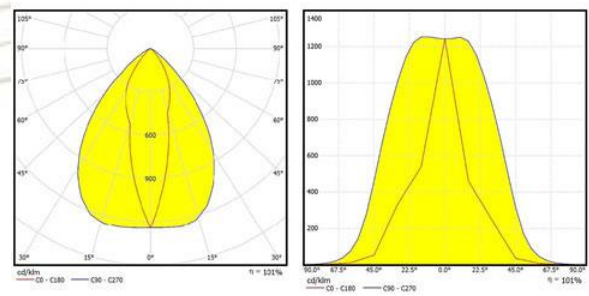

50x90°

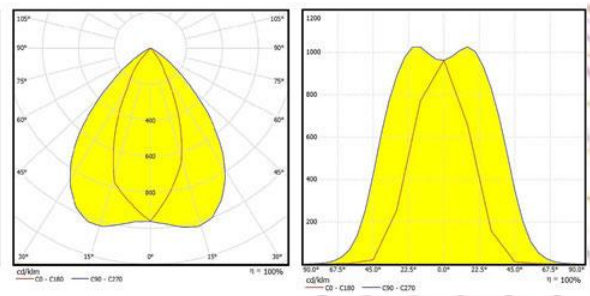

Email:sales@senslights.com

# SensLights LED lights

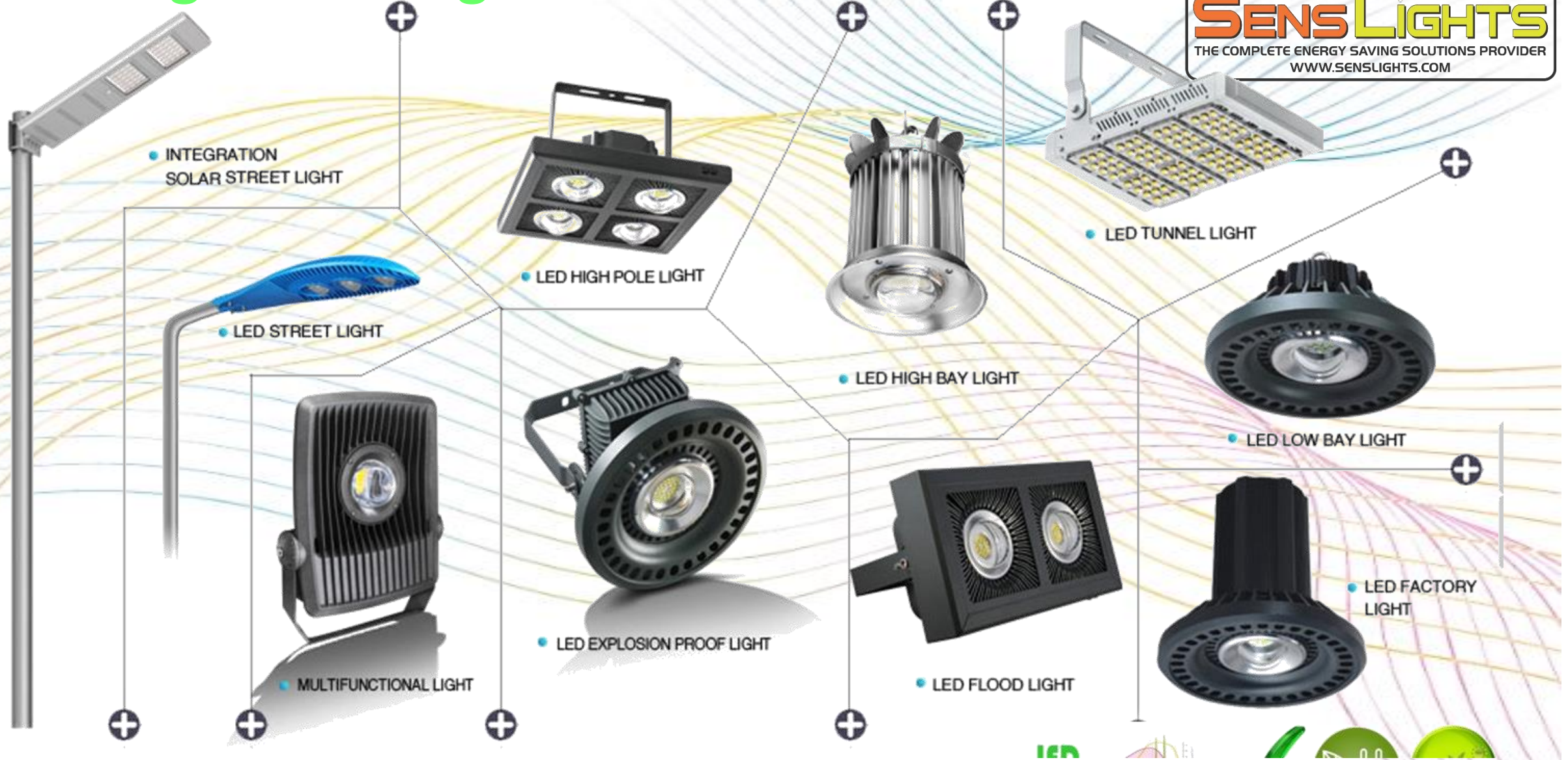

Email: [sales@senslights.com](mailto:sales@senslights.com)

# SensLights LED lights



**SLED ED010C**

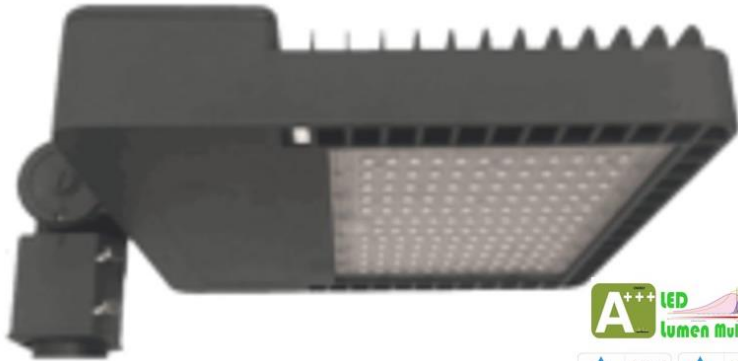

Die casting aluminum alloy  
 Size : 345 x 345 mm  
 LED: 100W / 120W / 150W

**SLED ED010D**

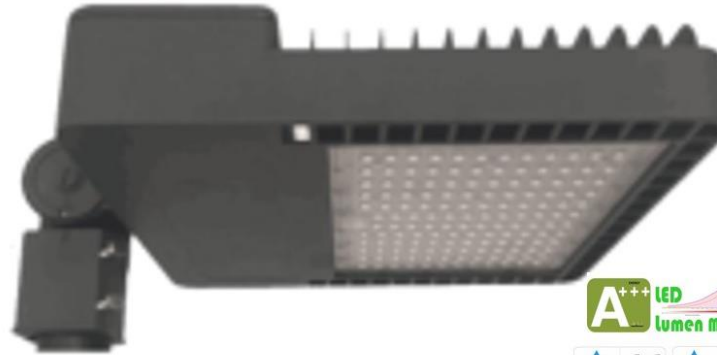

Die casting aluminum alloy  
 Size : 430 x 430mm  
 LED: 180W / 200W / 240W / 280w

**SLED ED010B**



Die casting aluminum alloy  
 Size : 420 x 420 mm  
 LED: 127W

**SLED ED010 A**



Die casting aluminum alloy  
 Size : 318 x 318 mm  
 LED: 76W



Email: [sales@senslights.com](mailto:sales@senslights.com)

# LED Panel lights

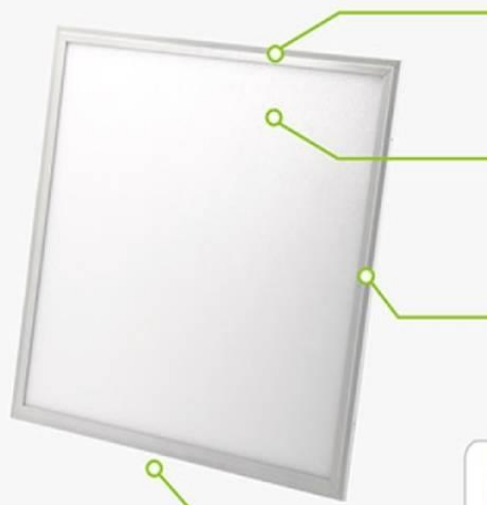

**White Frame**  
 Easily adapt to any ceiling T-bar ceiling grids

**Advanced Light Guide**  
 • 94% light output rate  
 • 87% total light transmittance rate

Ultra Brightness SMD2835  
 @55mA (Max.load 150mA)

**Quality Constant Current Driver**  
 PF>0.97  
 No flickering  
 PF>0.97 PE>88%  
 No flickering, double PFC

Stainless Steel Screw

Double Back Frame  
 Elegant Classic Design

Ultra Slim 9mm

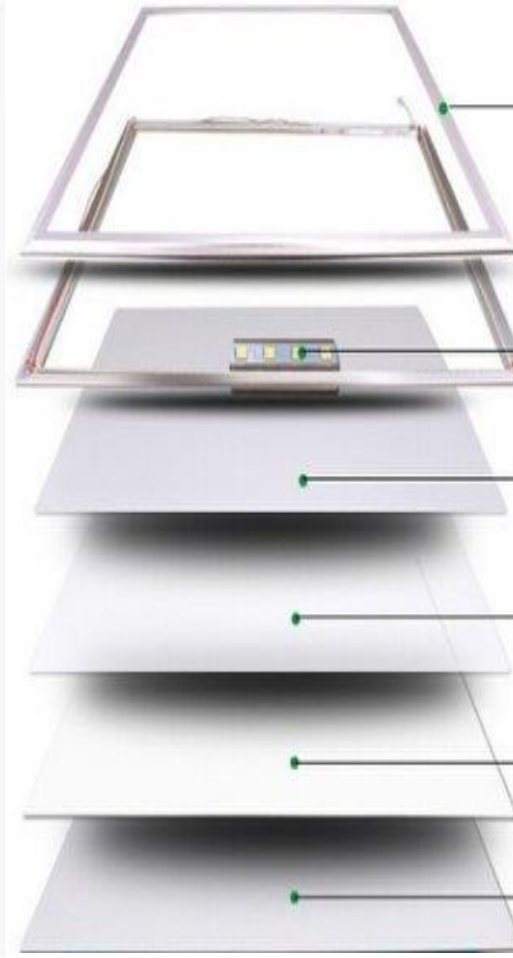

**Aluminium alloy frame**  
 Arenaceous silver aluminium alloy frame, sturdy and durable

**Import LED Chip**  
 USA Bridgelux or Taiwan Epistar SMD led chip, high brightness with low decay

**Diffuser plate**  
 Diffuser plate has perfect light transmittance property to ensures the light radiating evenly.

**Light guide plate**  
 Japanese imported light guide plate

**Reflective sheeting**  
 Reflective sheeting, 98% glisten rate, significantly improve luminous flux

**Sponge mat**  
 it's loose and porous, fast heat dissipation rate. which protect lamp better

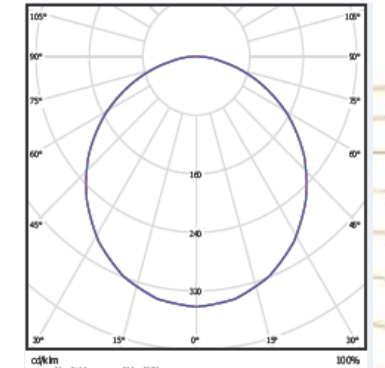
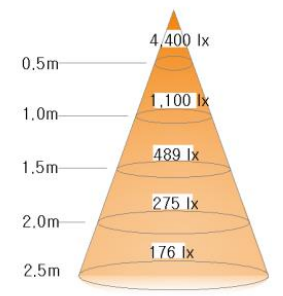

Accessories:  
 1. 20mm wire mesh  
 2. 20mm wooden frame

More thinner  
 More Cheaper  
 More Brighter



Email: [sales@senslights.com](mailto:sales@senslights.com)

# LED panel round lights

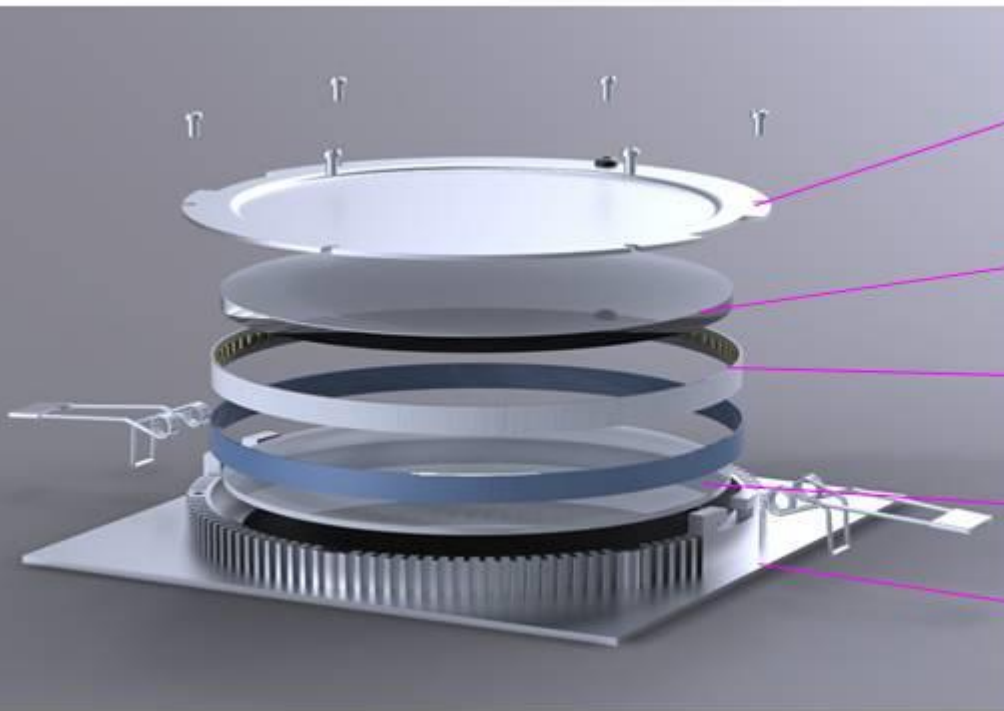

**Back Cover**

**Light Guide Plate**

**LED**

**Diffuser Plate**

**Front Cover**

- ① PC rear cover
- ② Aluminum heat sink
- ③ LED Light strip
- ④ Reflective paper
- ⑤ Light guide plate
- ⑥ Diffusion Plate
- ⑦ Surface frame



Email: [sales@senslights.com](mailto:sales@senslights.com)

# LED panel round lights

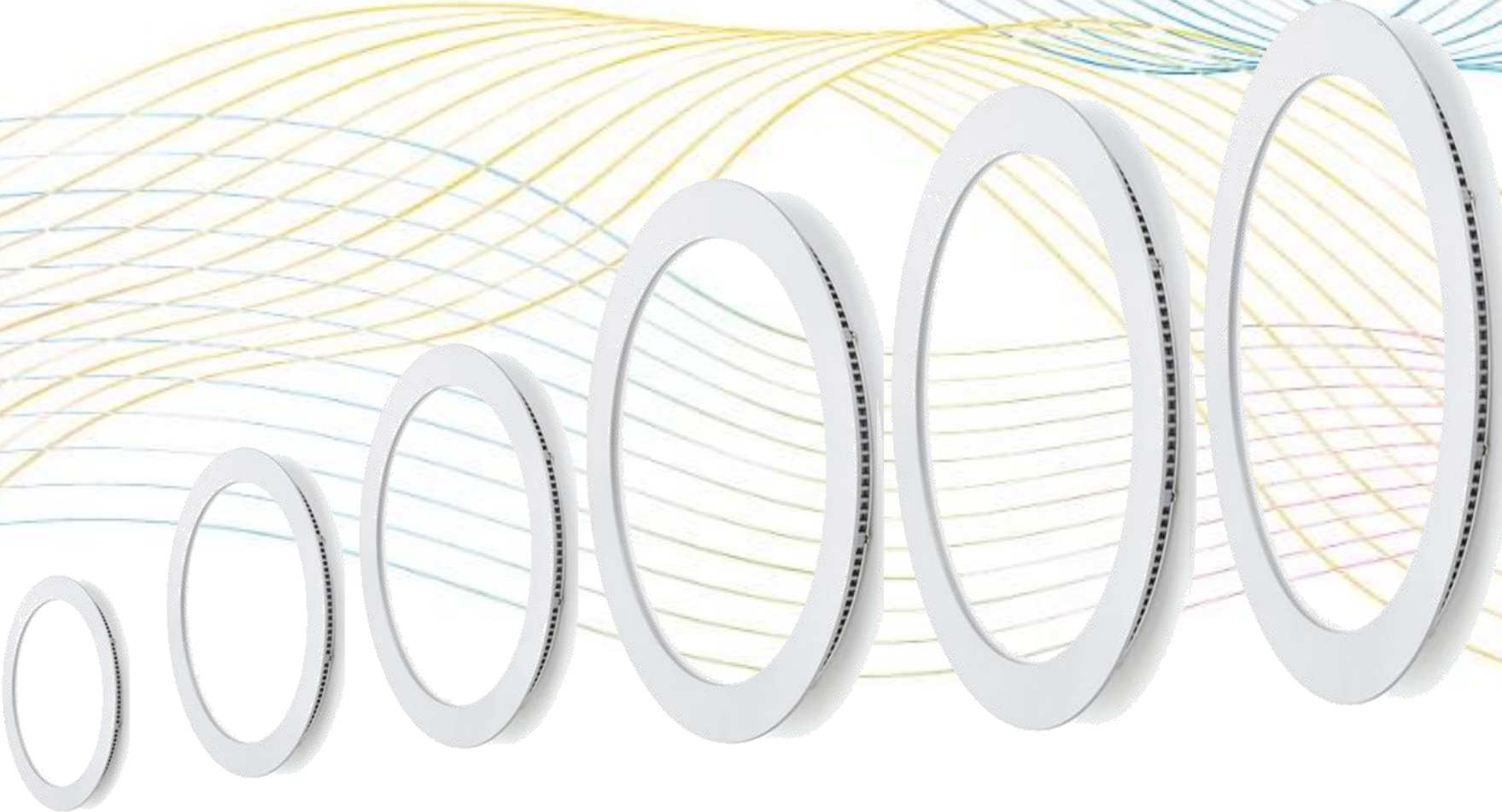

90mm 3W	100mm 4W	120mm 6W
145mm 9W	170mm 12W	195mm 15W
225mm 18W	300mm 24W	

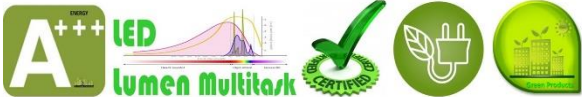

Email: [sales@senslights.com](mailto:sales@senslights.com)

# LED Con lights

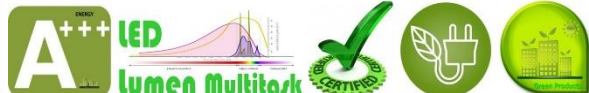

Email: [sales@senslights.com](mailto:sales@senslights.com)

# LED Con lights

Hot sale U shape series



Different color temp for choice



New design Spiral series



Different lamp base available



E27

E14

B22



Email: [sales@senslights.com](mailto:sales@senslights.com)





# LED E27 Bulb A60



Good quality anatomy for you to see



Email: [sales@senslights.com](mailto:sales@senslights.com)

# LED Tube lights



**The Latest solution - T8 LED tube**  
**- 20W 1.2m T8 2200lm**

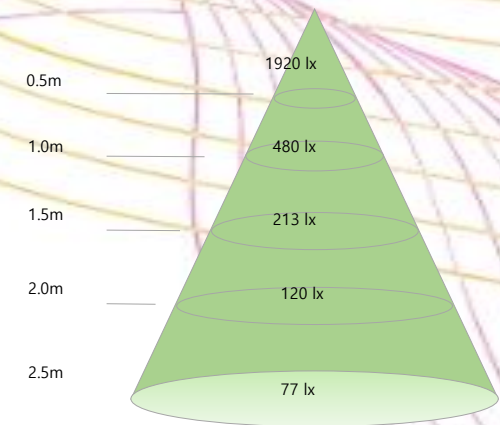
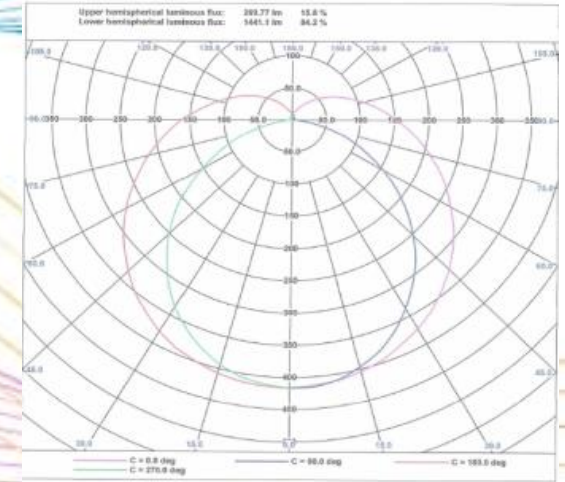
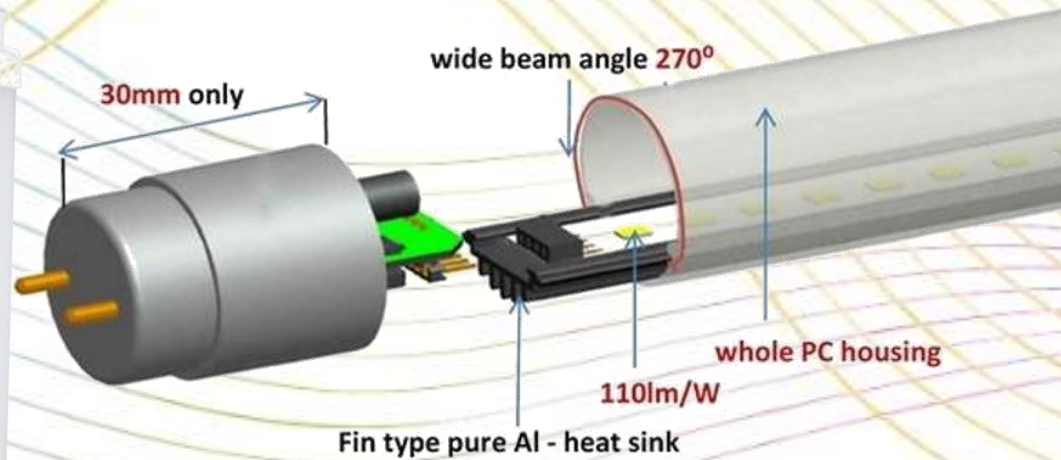

Email: [sales@senslights.com](mailto:sales@senslights.com)

# LED Tube lights with Sensor



Light sketch map for the lamp.

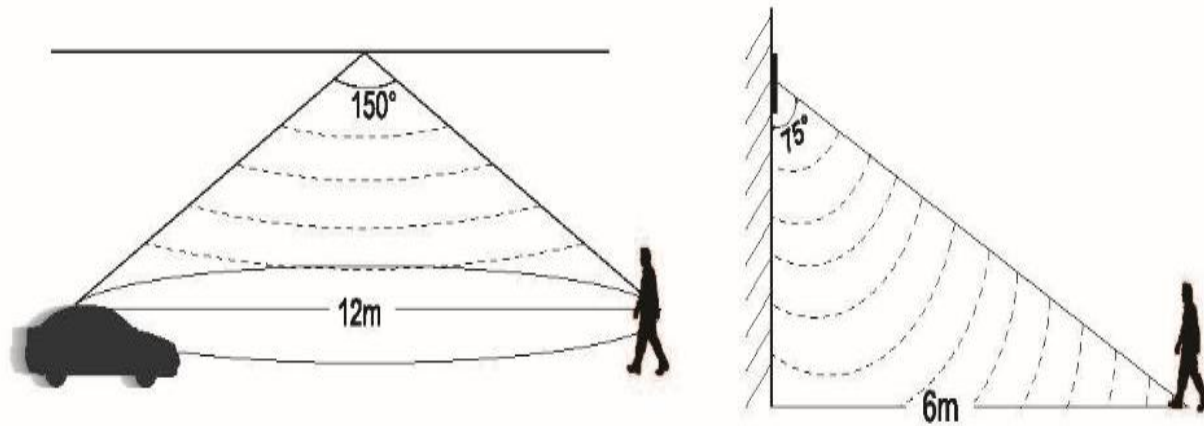

**LED TUBE Microwave Sensor**

- Maximum detection distance upto 12M**
- 180° rotatable provides accurate detection monitoring**
- Saves power up to 60% compared with similar products**

LED lumen Multitask, UKAS, CE, UL, RoHS

Email: [sales@senslights.com](mailto:sales@senslights.com)

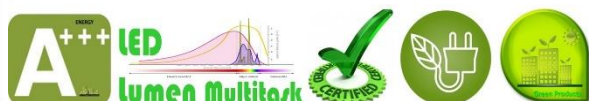

# LED Strip lights

3528 SMD LED Chip



5050 SMD LED Chip



3014 SMD LED Chip



3020 SMD LED Chip



2835 SMD LED Chip

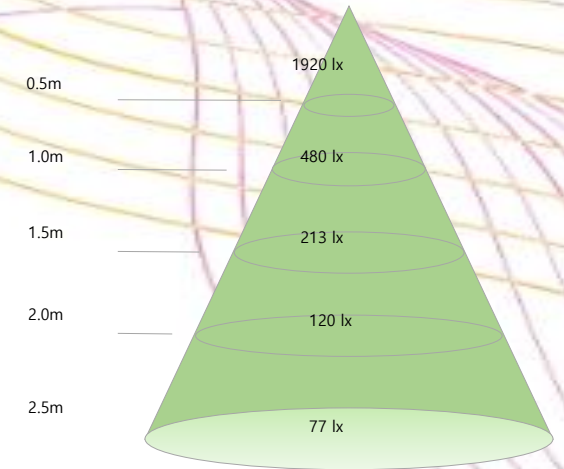
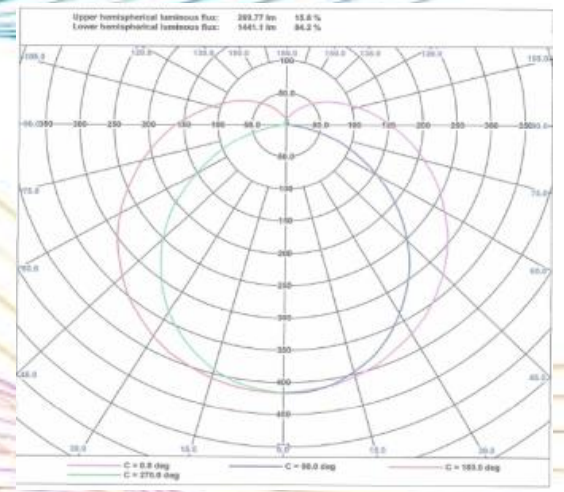

# LED surface mount lights

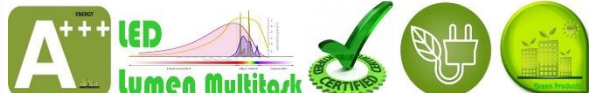
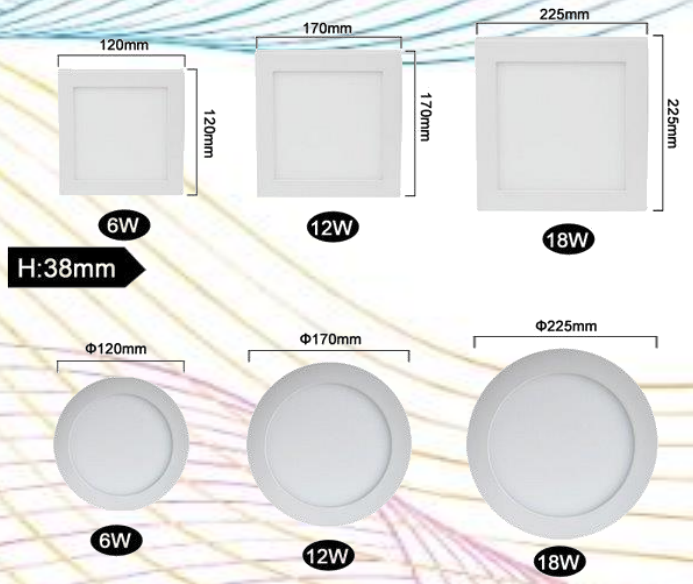

Email: [sales@senslights.com](mailto:sales@senslights.com)

# LED Filament Bulbs

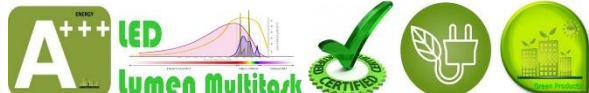

Email: [sales@senslights.com](mailto:sales@senslights.com)

# All type of LED Lights in SensLights



Rings + patent design heat sink = Ceiling light



Email: [sales@senslights.com](mailto:sales@senslights.com)

# LED flood Lights



80-FL800W1350W-08  
(ID:FA)



80-FL480W-08  
(ID:FA)



80-FL360W-08  
(ID:FA)



80-FL240W-08  
(ID:FA)



80-FL800W1350W-08  
(ID:FB)



80-FL480W-08  
(ID:FB)



80-FL360W-08  
(ID:FB)



80-FL240W-08  
(ID:FB)

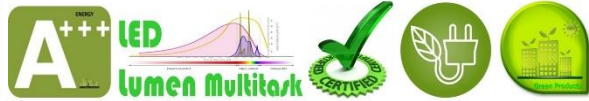

Email:sales@senslights.com



# LED flood Lights

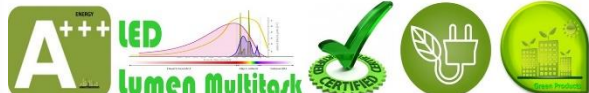

Email: [sales@senslights.com](mailto:sales@senslights.com)

# LED flood Lights



IP66 SMD



IP66 COB



IP66 SPOT



IP66 HIGH POWER

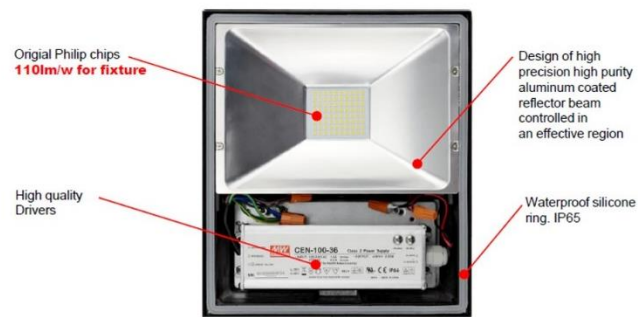

10W   1100lm	20W   2200lm	30W   3300lm	50W   5500lm
80W   8800lm	100W   11000lm	120W   13200lm	

30W	50W	100W	150W
L220*W205*H38MM 0.37Kg	L215*W250*H38MM 0.435Kg	L420*W280*H38MM 1.195Kg	L420*W280*H38MM 1.22Kg

IP65
110lm/w
PHILIPS
WARRANTY 3 years

Email: [sales@senslights.com](mailto:sales@senslights.com)



# LED Street Lights



SLED EA01302



SLED EA1306



SLED EA1307

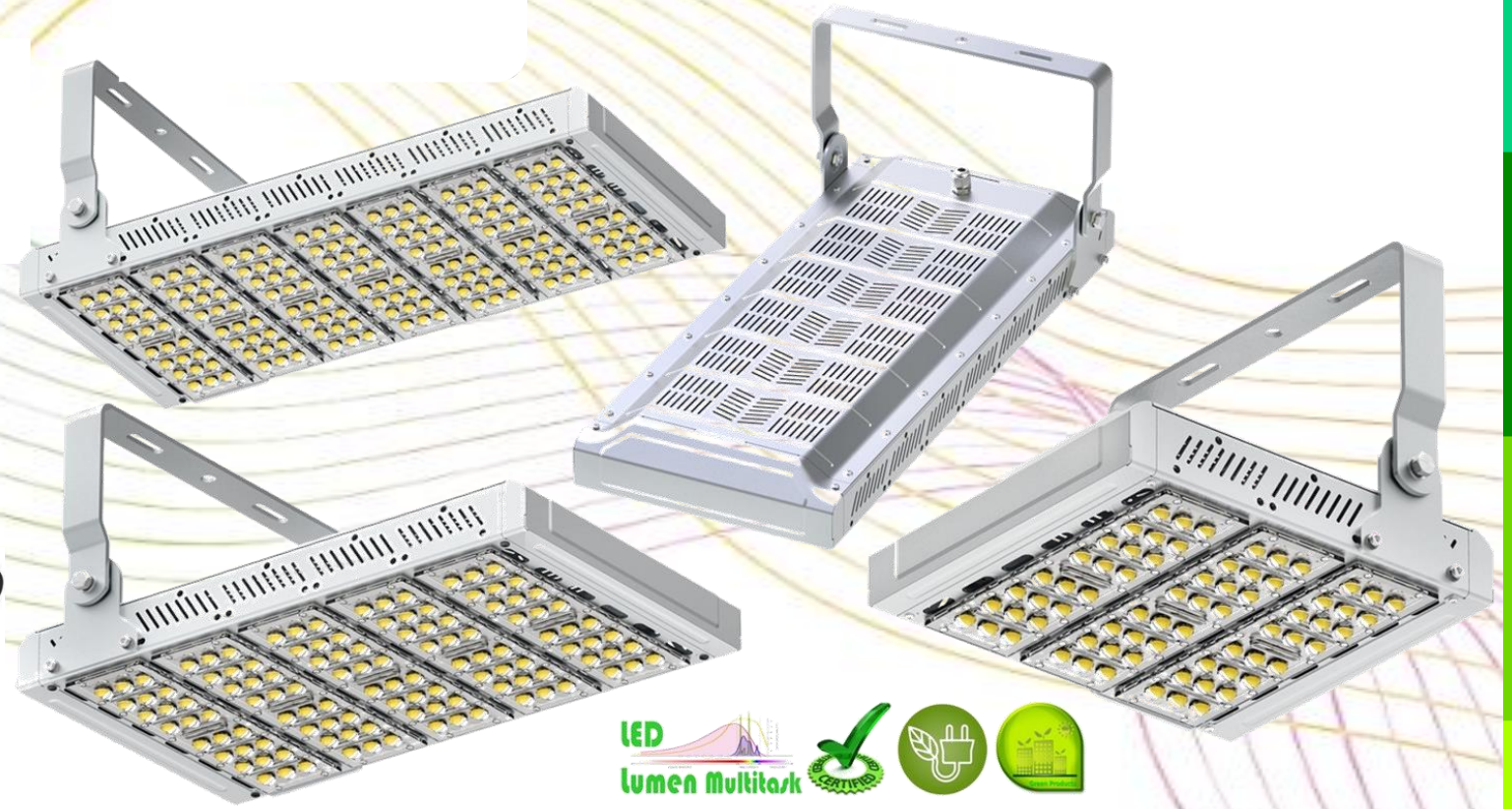

Email: [sales@senslights.com](mailto:sales@senslights.com)

# LED Street Lights



300W



400W

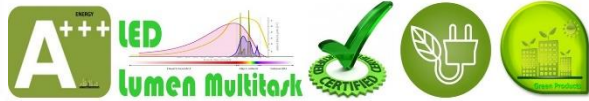

Email: [sales@senslights.com](mailto:sales@senslights.com)

# LED Street Lights



Email: [sales@senslights.com](mailto:sales@senslights.com)

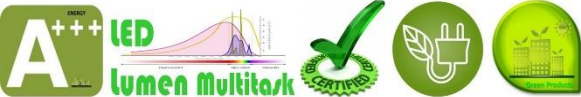

# LED Lighting



Dustproof LED Corn Light



Dustproof LED Corn Light



Dustproof LED Corn Light



LED corn light



LED Corn Light



LED Canopy Light



LED Tri-proof



LED linear high bay



LED UFO high bay



LED Street Light



Super Slim LED Wall pack



LED Shoebox Light



Email: [sales@senslights.com](mailto:sales@senslights.com)

# LED Street Lights



Email:[sales@senslights.com](mailto:sales@senslights.com)

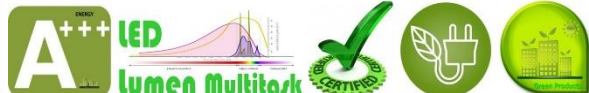

# Quality Certification

## Multitasking Corporation test report



SensLights LED Chip

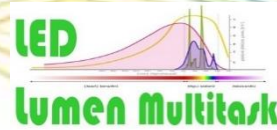

LED chip bright and Lumen testing

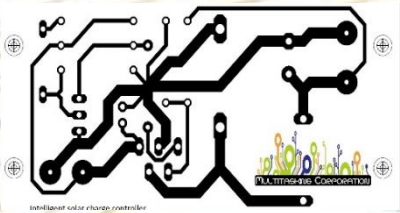

Intelligent LED Driver



Energy saving rating



Green Energy Products



Green & Eco Friendly Products



Quality Standard



Other Certification





Thank you  
[www.senslights.com](http://www.senslights.com)

Email: [info@senslights.com](mailto:info@senslights.com),  
[sales@senslights.com](mailto:sales@senslights.com), [support@senslights.com](mailto:support@senslights.com)

